

Varenummer: 0102140
 Beskrivelse: Seeger låsering J 185 DIN 472
 Fjederstål

Mål

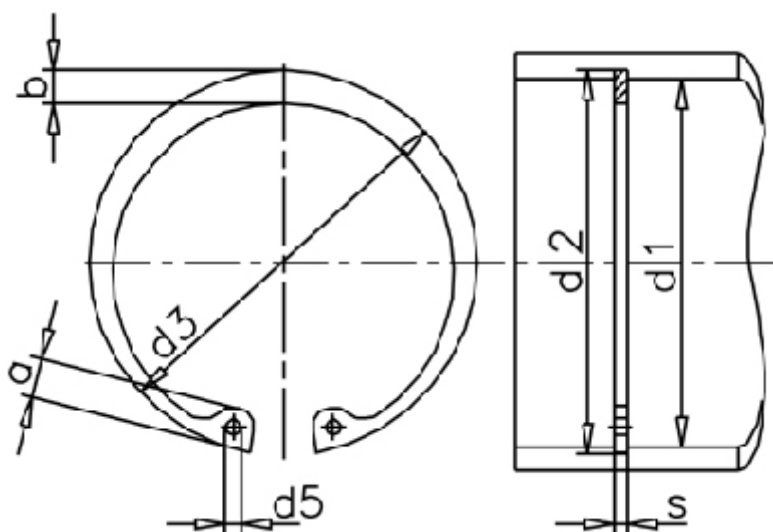

| | | | | | |
|--------------------|----------|--------------|----------|--------------|--------------|
| a max | = 14,2 | FN kN | = 245.00 | t | = 2.50 |
| AN mm ² | = 1471.0 | FRg kN | = 59.0 | Tang | = ZGJ-5 |
| b | = 13.7 | FR kN | = 349.0 | tol | = -0.10 |
| Betegnelse | = J 185 | g | = 3.5 | tol | = +1,70-0,72 |
| d1 | = 185 | K kN-mm | = 800.0 | tol | = +0,72 |
| d2 | = 190.0 | m min | = 4.15 | vægt kg/1000 | = 170.00 |
| d3 | = 194.50 | Nominel træk | = 7.5 | | |
| d5 min | = 4.0 | s | = 4.00 | | |